



www.scott-sports.com

All rights reserved © 2014 SCOTT Sports SA
SCOTT Sports SA | 17 Route du Crochet | 1762 Givisiez | Switzerland

Distribution: SSG (Europe) Distribution Center SA
P.E.D Zone C1, Rue Du Kiell 60 | 6790 Aubange | Belgium

V4.3/19012015

SCOTT BMX

BIKE OWNER'S MANUAL 2015





www.scott-sports.com

Congratulations on your purchase of a new SCOTT bicycle!

We are confident that the bicycle will exceed your expectations for value, performance, and ride quality. Each frame set and component has been carefully selected and designed to enhance your riding experience. Whether you are a beginner cyclist, or a seasoned pro, SCOTT bicycles will provide endless hours of two-wheeled fun.

We strongly recommend you take the time to read this manual and familiarize yourself with your new bicycle.

If you have purchased a bike for your child, please take the time to ensure they understand the safety information contained in this manual.

CONTENTS

Bicycle Safety	04
Saddle Height	05
Chain Tension	05
Brakes	06
Tires and Rims	09
Wheels	10
Maintenance and Care	13
Bicycle Care	15
Tightening Torques for SCOTT Bikes	16
Troubleshooting	17
Warranty	18
Parts of Wear and Tear	20
SCOTT Service Plan	22

BICYCLE SAFETY

IMPORTANT!

If you purchased this bicycle for a minor, it is essential that a responsible adult thoroughly reads and explains the safety instructions in this manual to the minor.

Please ensure your SCOTT bike is completely assembled by your authorized SCOTT dealer. This ensures that your bike is correctly set up to optimize safety, performance and fun while riding.

It is important to understand the basics of and exercise common sense when cycling. Cycling is a dynamic sport that requires awareness of and reaction to various situations and surroundings. Like any sport, cycling involves risks of injury and damage. By choosing to ride a bicycle, you assume the responsibility for those risks.

IMPORTANT!

Please use your bike only for the purpose it was made for.

For instance, a road racing bike should not be used as a substitute for a mountain bike in off road terrain. Nor should a Trekking bike be used for downhill racing or road racing.

If you have any questions regarding your new SCOTT bicycle, please contact your authorized dealer.

Ride Frequently!

- Obey all traffic laws.**
Use proper signals when turning.
Never tow yourself behind another vehicle.
Do not weave or race in traffic.
- Watch out for parked cars.**
A car door can open or a car can pull out into traffic at any time.
- Always ensure you are highly visible.**
Wear bright colors, install reflectors properly and use lights at night.
- Always wear a helmet.**
Ensure the helmet meets or exceeds national safety standards.
- Ensure that your bicycle is in good working condition before every ride.**
Check your brakes, tires, components, etc.
- Ensure that the bike is the right size.**
The rider should be able to reach the brake levers properly.
- Never have two people on a bicycle designed for one.**
Except specially designed and properly installed child carriers.
- Mount loads securely.**
Never mount anything that interferes with brakes or vision.

SADDLE HEIGHT

Comfortable riding depends on the position and height of the saddle. You can adjust the saddle height by:

- Straddle the saddle. Place the ball of your foot on the pedal nearest to the ground. Make sure the cranks are vertical.
- If the heel of your foot points down about 30 degrees, the saddle height is correct.

CAUTION!

Ensure that the limit marking on your seat post is inside the seat tube. If it is not possible to reach the correct seat height, you will need a larger size.

Ensure that the seatpost marking is inserted into the frame. If you need to change the inclination of the saddle or the horizontal position, ensure you do not exceed the max. tightening torque.

Screws with M5 should be tightened with 6 Nm, and M8 with 20 Nm.

Ensure the saddle is installed correctly with the seat post before every ride.

Please note that SCOTT is not responsible for damages caused by neglecting the tightening torques on the seatclamp fixing screws.

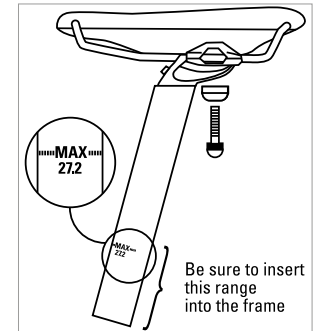

CHAIN TENSION

If the chain needs to be tensioned again, release nut A on both sides and pull the rear wheel straight backward until the tension is ok.

Retighten nut A on both sides. Please note the tightening torque in the Tightening Torques table at the end of this manual.

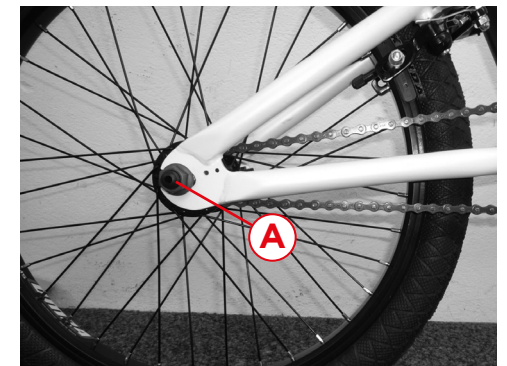

BRAKES

GENERAL BRAKE ADJUSTMENT

Your SCOTT bike is fitted with a reliable and well-functioning braking system, provided the brakes are correctly adjusted. Check by measuring the distance between the brake shoes and the rim: it should be 1.5 to 2 mm.

Cable connection and adjustment of the (Dual Pivot) brake

1. Put the quick release lever in the closed position.
2. Adjust the brake shoe clearance (as shown in the illustration) and secure the cable with the pinch bolt nut. Cable bolt tightening torque 6-8 Nm

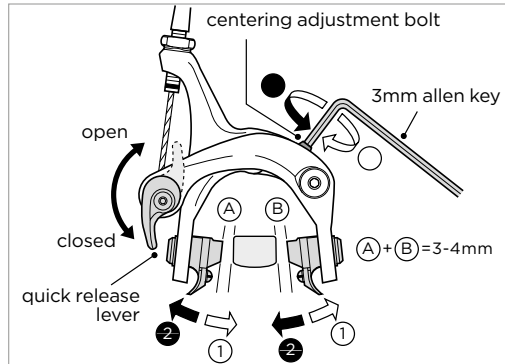

HOW TO CHANGE BRAKE PADS

1. Loosen the security screw with a 2 mm allen key.
2. Push the used brake pad out of the aluminum brake shoe.
3. Push the new brake pad into the brake shoe, according to the arrow showing the mounting direction.
4. Tighten the security screw to approximately 1.5 Nm.

CALIPER BRAKE

Release counter nut A and turn adjustment screw B counter clockwise until the distance between brake pads and rims is approx. 2mm on each side. Tighten counter nut A.

- If the adjustment screw B is released already to the limit, then release cable clamping screw C and turn adjustment screw clockwise to its original position.
- Close the caliper brake with your hand to the rim, adjust the brake cable and tighten clamping screw C. Please note the Tightening Torques table at the end of this manual.



- Finally make the fine tuning with adjustment screw B as mentioned above. The wheel needs to spin free without touching the brake pads. Fix counter nut A.

IMPORTANT!

Make sure that the brake works perfectly.

IMPORTANT!

Under wet conditions the brake performance can decrease which will result in a prolongation of the braking distance.

V-BRAKE

1. While holding the shoe against the rim, tighten the shoe fixing nut.
2. Pass the inner cable through the inner cable lead, and after setting so that the total of the clearances between the left and right shoes and the rim is 2 mm tighten the cable fixing bolt.

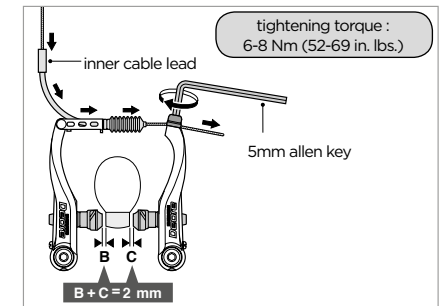

3. Adjust the distance with the spring tension adjustment screws.

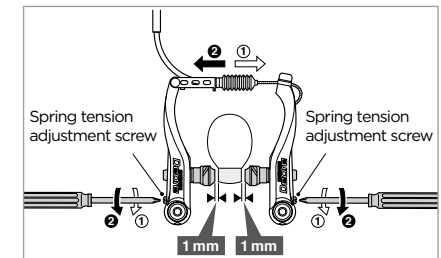

4. Depress lever about 10 times

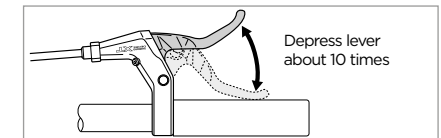

Replacement of the brake pads/cartridge shoe

Remove the shoe fixing pin

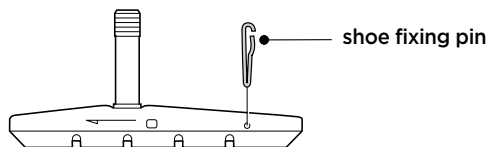

Remove the shoe by sliding it along the groove of the shoe holder

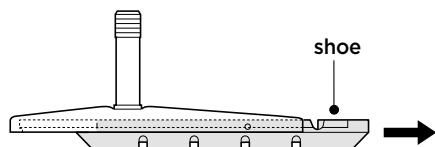

Make sure to use the correct brake pad and brake shoe for each side. Those for the left side are different from those for the right side. Slide the new pad into the shoe and make sure that the direction is correct and that the security pin holes concord.

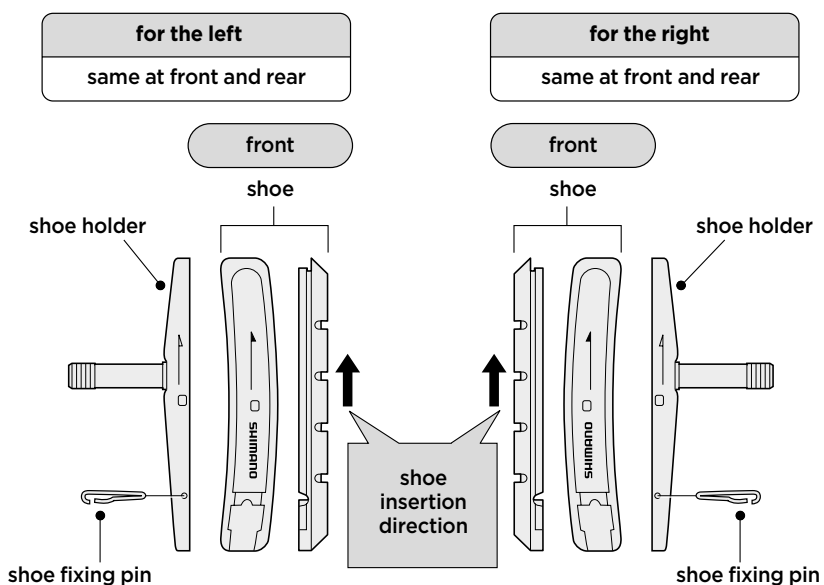

Insertion of shoe fixing pin is very critical to keep shoe properly fixed in place

TIRES AND RIMS

Tires should always be inflated within the manufacturer's recommendations. They are rated from 40 to 80 lbs. (check your tires).

Higher pressure for smoother roads or heavy riders.

Lower pressure for more shock absorption on rougher terrains.

For example:

INFLATE TO MIN. 3.5 (50PSI) - MAX. 6.0 BAR (85PSI)

RIM AND WEAR OF THE RIM

If the brake system has brake pads, please be aware that the rim will become worn through the action of braking.

When riding in wet and muddy terrain, for example, the rim is quickly worn out.

The appearance of small cracks or deformation of the brake surface on the rim when increasing the tire pressure indicates increased wear of the rim. If this occurs, the rim should be replaced immediately at an authorized dealer.

SCOTT bikes that are fully equipped (lights, mudguard, carrier) have a wear-out-indicator.

Please follow the instructions of the rim manufacturer shown in the manual or on the rim itself.

WHEELS

Bicycle wheels are designed to be removable for easier transportation and for repair of a tire puncture. In most cases, the wheel axles are inserted into slots, called “dropouts” in the fork and frame, but some suspension mountain bikes use what is called a “through axle” wheel mounting system.

If you have a mountain bike equipped with through axle front or rear wheels, make sure that your dealer has given you the manufacturer’s instructions, and follow those when installing or removing a through axle wheel. If you don’t know what a through axle is, ask your dealer.

Hex nuts or hex key bolts which are threaded on to or into the hub axle (bolt-on wheel, fig. 10)

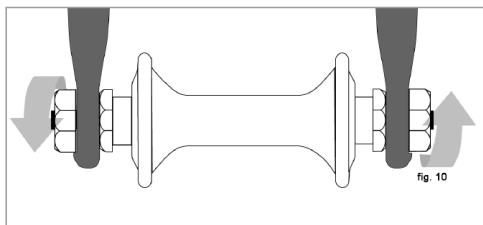

Your bicycle may be equipped with a different securing method for the front wheel than for the rear wheel. Discuss the wheel securing method for your bicycle with your dealer.

It is very important that you understand the type of wheel securing method on your bicycle, that you know how to secure the wheels correctly, and that you know how to apply the correct clamping force that safely secures the wheel. Ask your dealer to instruct you in correct wheel removal and installation, and ask him to give you any available manufacturer’s instructions.

FRONT WHEEL SECONDARY RETENTION DEVICES

Most bicycles have front forks which utilize a secondary wheel retention device to keep the wheel from disengaging if the quick release is incorrectly adjusted. Secondary retention devices are not a substitute for correct quick release adjustment. Secondary retention devices fall into two basic categories:

1. The clip-on type is a part which the manufacturer adds to the front wheel hub or front fork.
2. The integral type is molded, cast or machined into the outer faces of the front fork dropouts.

Ask your dealer to explain the particular secondary retention device on your bike.

WARNING!

Do not remove or disable the secondary retention device. As its name implies, it serves as a back-up for a critical adjustment. If the quick release is not adjusted correctly, the secondary retention device can reduce the risk of the wheel disengaging from the fork. Removing or disabling the secondary retention device may also void the warranty.

Failure to properly adjust the quick release mechanism can cause the wheel to wobble or disengage, which could cause you to lose control and fall, resulting in serious injury or death.

FIXING A FLAT TIRE

Bike tires are fitted with tubes.

Remove the wheel from the bike and deflate it. Unhook the tire from one side of the rim using tire tools. Do not screwdrivers.

Remove the tube from the tire casing, repair or replace it. Install the new or repaired tire. Fill the tube lightly with air in order to let it take its shape. Put the valve stem through the hole, and fit the inside tire. Put the tire bead in the rim starting at the valve and finishing at the opposite end, working on both sides. Push the valve stem into the tire and pull it back down to seat. Make sure the tube is not pinched under the tire bead. Inflate with hand or foot-pump.

Close the brake’s quick release system carefully.

USE OF A BICYCLE HAULER

SCOTT bikes are not intended to be used with haulers (load-haulers, kids-haulers, Trailer bikes).

Please note that SCOTT will not take any warranty or responsibility when using a hauler.

There are too many different haulers and hauler fixation systems on the market to give a detailed table of systems that might fit without technical problems or endangering the passengers.

USE OF A BABY SEAT

SCOTT bikes such as Racing Concept, Racing, Endurance, Progressive, Road, Roadster and Kids Series are not intended to be used with baby seats.

Please note that SCOTT will not take any warranty or responsibility when using a baby seat on bikes mentioned above.

There are too many different baby seat and baby seat fixation systems on the market to give a detailed table of systems that might fit without technical problems or endangering the passengers.

ASSIGNMENT OF BRAKE LEVERS TO FRONT AND REAR BRAKE

In general SCOTT bikes are delivered and preassembled with the right lever matching the rear brake and the left lever matching the front brake.

Due to national laws this may have been changed by your SCOTT dealer to fulfil the national laws.

Please ask your dealer to explain to you the assignment of the brakes and brake levers when handing over the bike.

MAXIMUM WEIGHT AND LOAD OF SCOTT BIKES

SCOTT mountain bikes are intended for a maximum rider weight of 110 kgs, the overall weight of bike including rider should not exceed 119-128kgs (depending on bike weight).

SCOTT trekking bikes are intended for a maximum rider weight of 110 kgs, the overall weight of bike including rider and a maximum load of 25kgs should not exceed 143-150kgs (depending on bike weight).

SCOTT road bikes are intended for a maximum rider weight of 110 kgs, the overall weight of bike including rider should not exceed 117-120kgs (depending on bike weight).

SCOTT kids bikes are intended for a maximum load of 50 kgs including rider and load.

Please always follow the information of the component suppliers regarding the maximum rider weight.

USE OF SCOTT BIKES IN PUBLIC TRAFFIC

Please follow the national laws concerning the use of equipped and non-equipped bikes in public traffic. For example, reflectors and light systems.

MAINTENANCE AND CARE

MAINTENANCE SCHEDULE

Please be aware that you must follow the list of maximum tightening torques for screws at the end of this chapter.

CHECK BEFORE EVERY RIDE:

- All bolts and nuts, especially the quick releases of the wheels for proper fit. If they are loose tighten them according to the maximum tightening torque.
- Stem and handlebar for visible damage and replace them if necessary. Ensure that the bolts are tightened evenly when closing the front cap according to the tightening torque recommended by the producer of the parts.
- Braking systems.
- Air pressure of the tires according to the recommendation of the producer.
- Light systems and bell.
- Handlebar grips to be fixed to the handlebar.
- All parts of the rear suspension system including mounting bolts.
- The front suspension fork on perfect function and play in the bushings.

CHECK ADDITIONALLY EVERY MONTH

- Front and rear derailleur for perfect function and grease them. Readjust the system and clean it if necessary.
- The play of the headset. Readjust it if necessary.
- Brake and shifting cables on perfect wear and leakage on hydraulic systems. Grease the cables if necessary.

CHECK WHEN NECESSARY OR AT LEAST ONCE A YEAR AT YOUR LOCAL DEALER

- Chain wear and tension (on bikes equipped with internal gear hubs). Readjust if necessary, clean and grease the chain.
- Bottom bracket cartridge for play, replace it if necessary.
- Pedal bearings for play, replace them if necessary.
- Front and rear derailleur for perfect function and grease them. Readjust the system and clean it if necessary.
- Stem and handlebar for visible damage and replace them if necessary. Ensure that the bolts are tightened evenly when closing the front cap, according to the tightening torque recommended by the producer of the parts.
- Complete brake system on perfect function and readjust and grease it if necessary. Replace worn out or defective parts. Replace leaking hydraulic pipelines at once .
- Rims and tension of spokes. If necessary true them.
- Air pressure of the tires according to the recommendation of the producer.
- Overall condition of the tires.
- Light systems and bell.
- Handlebar grips to be fixed to the handlebar.
- All parts of the rear suspension system including mounting bolts.
- The front suspension fork on perfect function and play in the bushings.
- Frame and fork on perfect condition, replace if damaged.

SPARE PARTS FOR YOUR SCOTT BIKE

When buying spare parts we strongly recommend visiting your local SCOTT dealer as they will be best equipped with the knowledge, advice and specific parts that are correct for your bike.

By doing so you can avoid using wrong or incorrectly installed parts that could damage your bike or cause personal injuries. This is extremely important on parts of the brake system, the tire and air tube.

Please only use original spare parts as only these can guarantee optimum function and safety while riding. Please note that SCOTT is not responsible for damages caused by not using original spare parts.

Never use adapter solutions on parts such as brakes, seat/seatpost, stem/handlebar!

BICYCLE CARE

We recommend periodical care in order to keep your bike functioning well and in good condition.

Doing so maintains the value of the bike and helps to prevent corrosion or other damages.

- Clean using a soft brush, water and soft towel. Do not use a high pressure cleaner, otherwise bearings, colors or decals may become damaged
- Do not use aggressive cleaning substances
- Repair any damage to the paint immediately
- Grease or oil all metal parts especially during winter use

Please use biodegradable bicycle cleaners and degreasers which are available from your local SCOTT dealer.

TIGHTENING TORQUES FOR SCOTT BIKES

PART	MOUNTING BOLT	MAX. TORQUE
Rear Derailleur	- Mounting bolt - Cable fixing bolt - Pulley screws	7.8-9.8 Nm 3.9-5.9 Nm 2.9-3.9 Nm
Front Derailleur	- Clamp - Cable fixing bolt	4.9-6.8 Nm 4.9-6.8 Nm
Rapidfire lever	- Clamp mounting bolt	4.9-6.8 Nm
STI	- Clamp mounting bolt	4.9-6.8 Nm
Brake lever	- Clamp mounting bolt	4.9-6.8 Nm
Freewheel hub	- Freewheel body - Cassette fixing nut	35-49 Nm 30-49 Nm
Crankset	- Square type - Spline type - Chainring screws	35-45 Nm 35-50 Nm 7.8-10.7 Nm
BB-Cartridge		50-70 Nm
Pedals		40 Nm
Stem	Mounting bolts - M5 - M6	5.6-7.8 Nm 9.8-13.7 Nm
Seatpost-seatclamp	- M4 - M5 - M6	2.8-3.9 Nm 5.6-7.8 Nm 9.8-13.7 Nm
V-Brake	- Frame mounting bolts - Cable fixing bolt - Brake pad bolts	5-6.8 Nm 5.8-7.8 Nm 5-6.8 Nm
Caliper Disc brake	- Magura - Shimano - Formula - Hayes	6 Nm 6-8 Nm 9 Nm 12 Nm
Disc mounting bolts	- Magura - Shimano - Formula - Hayes	4 Nm 2-4 Nm 6.2 Nm 5 Nm

TROUBLESHOOTING

TROUBLE	REASON	SOLUTION
Fork Shakes	Headset Loose	Tighten and Lock
Chain Pops Out	- Derailleurs Not Adjusted - Chainwheel Bent	- Adjust According to Manual - Fix or Change
Bearings Squeak or Crack	- Bottom Bracket - Pedals Need Grease - Hubs Need Grease	- Replacement - Dismount, Clean, Grease - Dismount, Clean, Grease
Bearings Are Loose	- Bottom Bracket - Pedals - Hubs	- Replacement - Tighten and Lock - Tighten and Lock
Handlebar Cracks, Shakes	Stem Or Handlebar Bolts Are Loose or Turn	Tighten All Bolts and Nuts
Seat Post Turns or Slides	- Quick Release is Loose - Seat Post Diameter Too Thin	- Retighten and Lock - Check Diameter
Front Derailleur Rattles	- Bottom Bracket Loose - Not Adjusted - Chainwheel Bent	- Tighten Bottom Bracket - Adjust - Fix or Change
Suspension Fork is Loose		Contact Your Local Dealer
Rear Suspension is Loose		Contact Your Local Dealer

WARRANTY

What is Covered?

This warranty covers defects in materials and workmanship at the time of transfer of risks in frames, swingarms and forks (provided it is a fork of SCOTT) on SCOTT branded bikes sold completely assembled by SCOTT or an authorized SCOTT dealer (“Product”).

How Long Does Coverage Last?

This voluntary manufacturer’s warranty is limited to five years for frames and swingarms, respectively two years for forks, from the date of purchase of the Product and is limited to the first purchaser of the Product. Transfer of the Product from the first purchaser to another person terminates this limited warranty.

The limited warranty of five years for the frames and swingarms shall only be granted in case once a year a maintenance service has been effected according to maintenance requirements as set forth in the manual. The effected annual maintenance service shall be confirmed by stamp and signature. In case such an annual maintenance service has not been effected the warranty of five years for the frame shall be reduced to three years. Costs for maintenance and service have to be borne by the owner of the Product. On Gambler, Voltage Fr and Volt-X the warranty period is limited to two years.

Repaired or replaced Products are covered for the remainder of the original warranty period and subject to the conditions outlined in the original warranty, to the extent permitted by law.

Hereby SCOTT grants a worldwide voluntarily manufacturer’s warranty. To the extent permitted by law and unless a shorter duration is stipulated by law, any warranties implied by law are limited in duration to maximum five, respectively two years, from the date of purchase of the Product and are limited to the first purchaser of the Product.

What Will SCOTT Do?

SCOTT will replace by similar kind and quality or repair any defective Product, or will refund your purchase price (as evidenced by your tendered receipt of purchase of the Product), at SCOTT’s option. You must pay charges in connection with replacement of any non-defective parts. In such a case, you will be alerted to the advisability of replacing non-defective parts, so you can pre-authorize the costs.

What Does This Limited Warranty Not Cover?

This limited warranty does not cover defects which did not exist before the transfer of risks. This limited warranty does not cover Products used in rental operations. This limited warranty does not cover purchases of not completely assembled bikes. This limited warranty does not cover any defect caused by “wear and tear” (a complete list of all parts of “wear and tear” can be found in the manual), accident, neglect, improper handling, abuse, misuse, an act of God, improper assembly, non-compliance with recommended maintenance and care procedures, improper or incorrectly performed maintenance or repairs performed by someone other than an authorized SCOTT dealer, use of parts or devices not consistent with the Product, and alteration of the Product. All Products come with a manual; please carefully follow the instructions located there or affixed elsewhere to the Product. To the extent permitted by law, consequential and incidental damages are not recoverable under this limited warranty.

WARRANTY

How Do You Make a Claim Under This Limited Warranty?

To make a claim under this limited warranty, you must notify SCOTT of the claimed defect within the warranty period and timely return the Product to SCOTT at your expense for inspection. Please contact your authorized SCOTT dealer, call SCOTT’s customer service or the national SCOTT distributor (dealer locator: www.scott-sports.com). All returned Products must be accompanied by proof of purchase (receipt) from an authorized SCOTT dealer or this limited warranty will not apply. In case of replacement or refund, returned Product becomes the property of SCOTT.

A protocol for the handing over of the Product (which you will find at the end of the manual) will remain in copy at the SCOTT dealer after acceptance and signature of the consumer. It is obligatory to show this protocol of handing over together with the defective part in case of a warranty claim given that it provides evidence of purchase or this limited warranty will not apply.

How Do State Laws Affect Your Rights Under This Limited Warranty?

This limited warranty gives you specific legal rights, and you may also have other rights, which vary from state to state.

Recommendation

We strongly recommend that you use only authorized SCOTT dealers for yearly maintenance services and for repairs, as improper or incorrectly performed maintenance or repairs voids this limited warranty. Costs for maintenance service have to be borne by the consumer.

SCOTT Bike Warranty Periods					
	Year 1	Year 2	Year 3	Year 4	Year 5
SCOTT Bikes					
Gambler, Voltage FR, Volt-X					
Regular Warranty Period					
Option for prolongation according to maintenance intervals shown in manuals attached to bikes					

PARTS OF WEAR AND TEAR

PARTS OF WEAR AND TEAR ARE EXCLUDED FROM ANY WARRANTY.

CHAIN

The chain is subject to wear and tear due to its use. The extend of the wear and tear depends on the maintenance and conditions the bike is subjected to (amount of kilometers, rain, dirt, salt, etc.).

Cleaning and greasing will help to prolong the life of the chain but it is the responsibility of the owner to replace the chain when reaching the wear limit.

SPROCKETS, CHAINRINGS AND PULLEYS

The sprockets, chainrings and pulleys are subject to wear and tear due to their use. The extend of the wear and tear depends on the maintenance and conditions the bike is subjected to (amount of kilometers, rain, dirt, salt, etc.).

Cleaning and greasing will help to prolong the life of the sprockets, chainrings and pulleys, but it is the responsibility of the owner to replace them when reaching their wear limit.

SHIFTING AND BRAKE CABLES

All cables must be checked regularly and changed if necessary. Cables may need to be changed more regularly if the bike is often left outside or exposed to weather.

BRAKE PADS

All brake pads, whether they are rim-brakes, disc-brakes or internal brakes, are subject to wear and tear due to their use.

The extend of the wear and tear depends on the maintenance and conditions the bike is subjected to (amount of kilometers, rain, dirt, salt, etc.).

Check your brake pads regularly and replace them if necessary.

RIMS

When using rim brakes, not only are the brake pads subject to wear and tear, but also the rim. So regularly check the rims, e.g. when inflating the tires.

If you see small cracks or deformation in the brake surface of the rim while inflating the tires, then replace the rim immediately.

Rims with wear-out indicators enable the bike user to easily check the condition of the rim. Refer to the sticker on the rim.

TIRES

The tires are subject to wear and tear due to their use. The extend of the wear and tear depends on the maintenance and conditions the bike is subjected to and is influenced by the owner's riding style.

Aggressive braking will reduce the lifetime of the tire dramatically.

In addition, check the air pressure regularly and inflate the tire according to the pressure recommended by the producer of the tire which is imprinted on the sidewall of the tire.

LIGHT SYSTEMS AND REFLECTORS

A well functioning light system is incredibly important for your riding safety in public traffic. Before every ride check your front and tail lights and the condition of the reflectors. Light bulbs are subject to wear and tear and we recommend taking replacements with you in case of failure.

HANDLEBAR GRIPS

Handlebar grips are subject to wear and tear due to their use and should be replaced immediately if they no longer fit to the handlebar or become loose.

HANDLEBAR, STEM AND SEAT POST

The handlebar, stem and seat post are subject to high dynamic forces while riding.

Please check these parts regularly for visible cracks or damage and replace them if necessary.

In addition, we recommend a periodical replacement (every two years) of these parts if you ride often and hard.

SCOTT SERVICE PLAN

Model

Year

Size

Frame

Date of purchase

Annual service to be done

- Check of shock mounts incl. lubricating the bushings
- Check of swingarm pivot incl. axle and mounts
- Check of rear shock according to the enclosed shock manual
- Check of hubs, bottom bracket and headset
- Check of all screws of the bike
- Check of handle bar, stem, saddle rails and seat post
- Check if brakepads and rims are worn out
- Check of disc brake according to enclosed service manual
- Check of suspension fork according to enclosed service manual
- Check of shifters and derailleurs incl. cables.

Date of Service:

Dealer's Signature:

SCOTT SERVICE PLAN

Model

Year

Size

Frame

Date of purchase

Annual service to be done

- Check of shock mounts incl. lubricating the bushings
- Check of swingarm pivot incl. axle and mounts
- Check of rear shock according to the enclosed shock manual
- Check of hubs, bottom bracket and headset
- Check of all screws of the bike
- Check of handle bar, stem, saddle rails and seat post
- Check if brakepads and rims are worn out
- Check of disc brake according to enclosed service manual
- Check of suspension fork according to enclosed service manual
- Check of shifters and derailleurs incl. cables.

Date of Service:

Dealer's Signature:

SCOTT SERVICE PLAN

Model

Year

Size

Frame

Date of purchase

Annual service to be done

- Check of shock mounts incl. lubricating the bushings
- Check of swingarm pivot incl. axle and mounts
- Check of rear shock according to the enclosed shock manual
- Check of hubs, bottom bracket and headset
- Check of all screws of the bike
- Check of handle bar, stem, saddle rails and seat post
- Check if brakepads and rims are worn out
- Check of disc brake according to enclosed service manual
- Check of suspension fork according to enclosed service manual
- Check of shifters and derailleurs incl. cables.

Date of Service:

Dealer's Signature:

SCOTT SERVICE PLAN

Model

Year

Size

Frame

Date of purchase

Annual service to be done

- Check of shock mounts incl. lubricating the bushings
- Check of swingarm pivot incl. axle and mounts
- Check of rear shock according to the enclosed shock manual
- Check of hubs, bottom bracket and headset
- Check of all screws of the bike
- Check of handle bar, stem, saddle rails and seat post
- Check if brakepads and rims are worn out
- Check of disc brake according to enclosed service manual
- Check of suspension fork according to enclosed service manual
- Check of shifters and derailleurs incl. cables.

Date of Service:

Dealer's Signature: